



30 JUNE 2020
PRELIMINARY RESULTS
INVESTOR PRESENTATION

PAUL SWINNEY, CEO
LIZ DIXON, CFO

19-21 OCTOBER 2020

FINANCIAL HIGHLIGHTS

- Turnover up 21% to £31.7m (2019: £26.2m)
- Overseas sales up 32% to £19m (2019: £14.4m), representing 60% of total sales (2019: 55%)
- Gross margin increased to 80% from 79% in 2019
- EBITDA before share-based payments up 38% to £9.8m (2019: £7.1m)
- EBITDA margin before share-based payments of 31% (2019: 29%)
- Pre-tax profit before share-based payments up 27% to £7.1m (2019: £5.6m)
- Pre-tax margin before share-based payments increased to 22% (2019: 21%)
- EPS before share-based payments up 11% to 12.35p (2019: 11.08p)
- Dividend per share for the full year increased by 12% to 6.18p (2019: 5.54p)
- Net cash of £6.2m (2019: £4.2m)

SALES HISTORY SINCE IPO

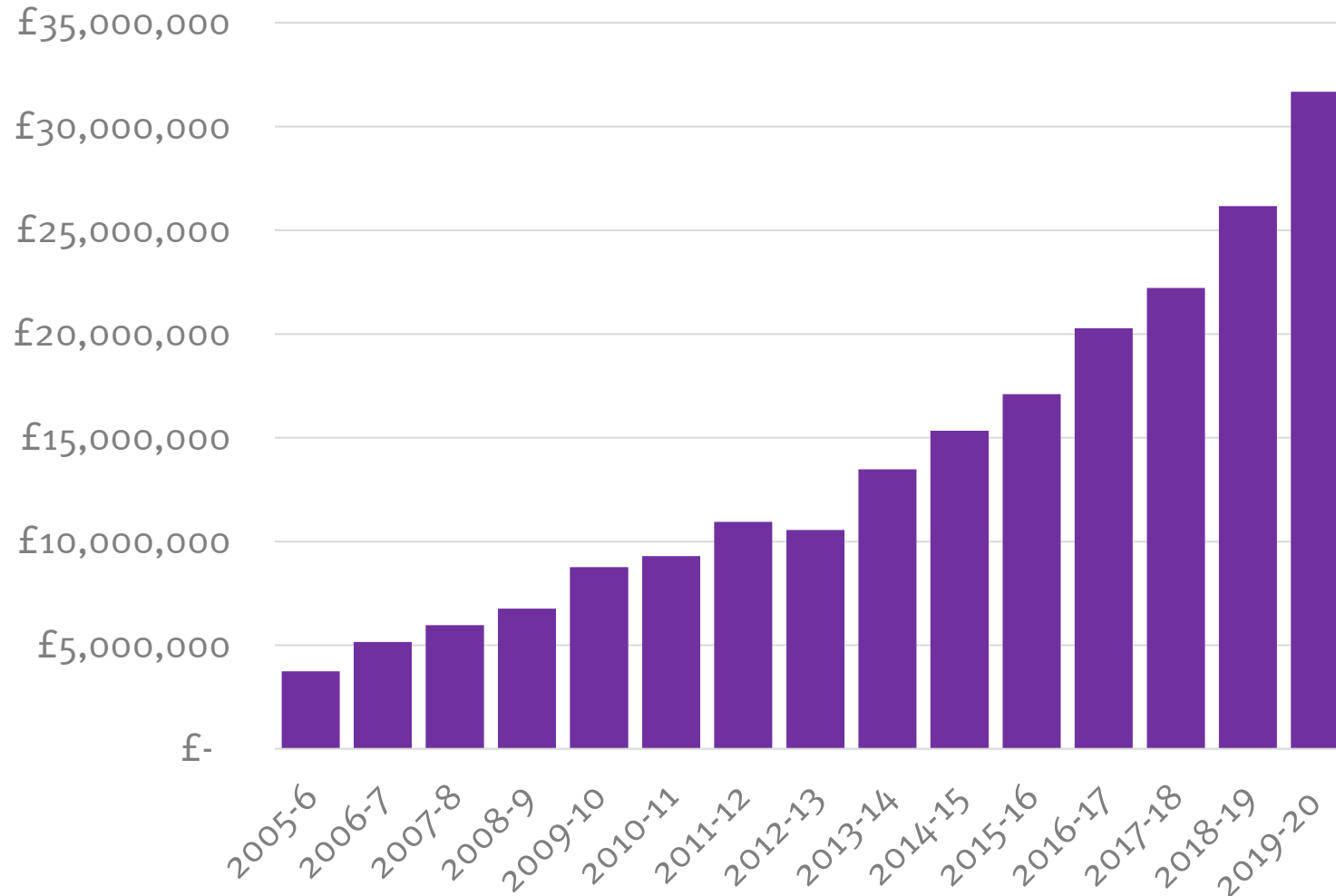

2019-20 in summary

- 21% y-o-y sales growth in 2020
- 17% CAGR since IPO
- Acquisition of Tristel Italia
- Launch of Cache Collection
- Impact of COVID-19

SALES HISTORY BY GEOGRAPHY

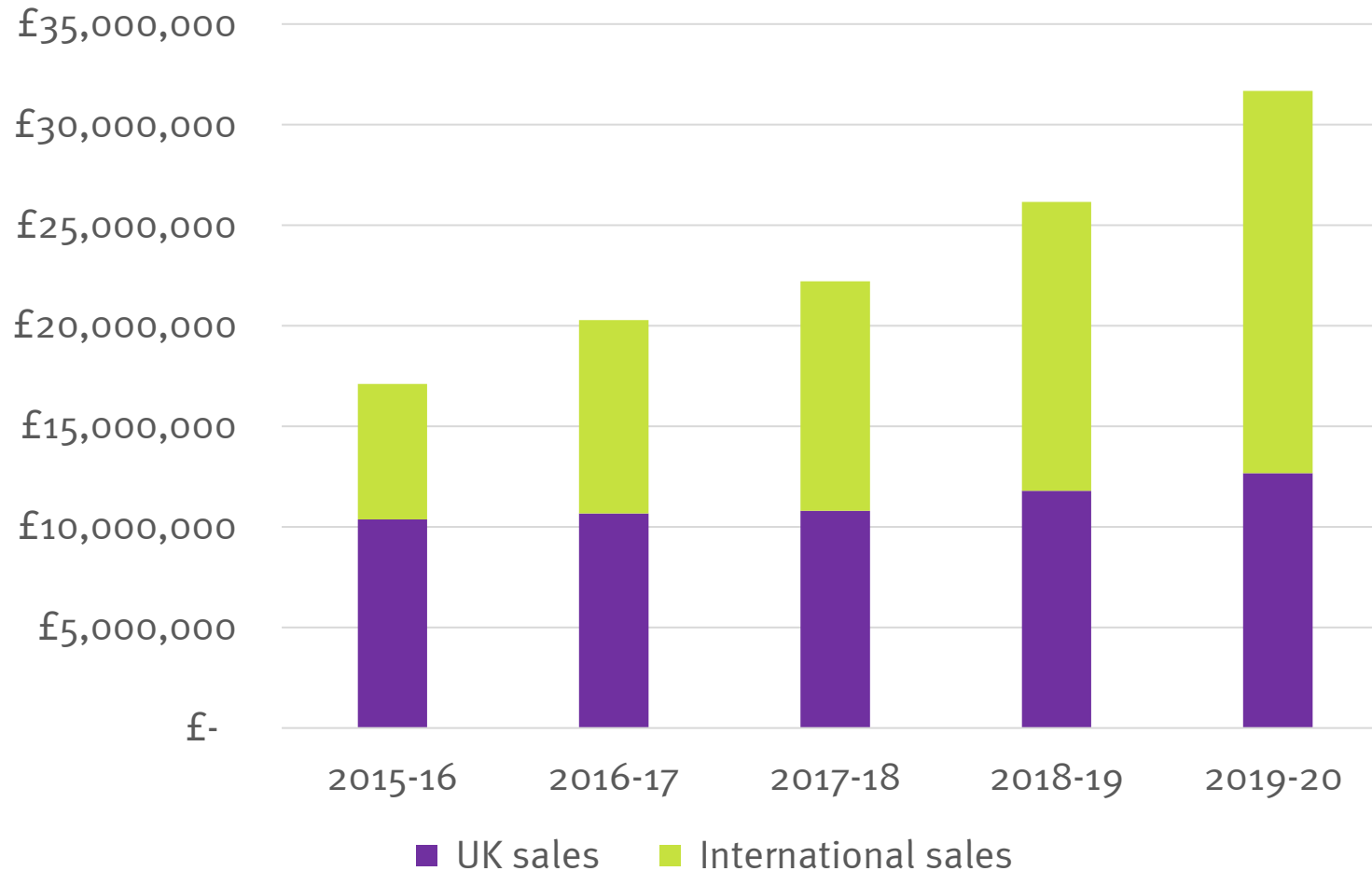

2019-20 in summary

- International sales growth 32%
- International sales benefit from Tristel Italia acquisition July 19, contribution of £0.5m
- International sales now 60% of the total
- UK sales growth 7%

SALES GROWTH BY GEOGRAPHY

£,000	2018-19	2019-20	Year on year change	% change
Central & Eastern Europe	4,610	5,320	710	15%
Western Europe	2,140	4,600	2,460	115%
Italy	-	670	670	100%
Australasia	3,300	3,530	230	7%
Hong Kong	980	1,170	190	19%
China	200	450	250	123%
Worldwide distributors	3,140	3,270	130	4%
Total Overseas	14,370	19,010	4,640	32%
United Kingdom	11,800	12,670	870	7%
Total Group	26,170	31,680	5,510	21%

SALES HISTORY – BY PRODUCT

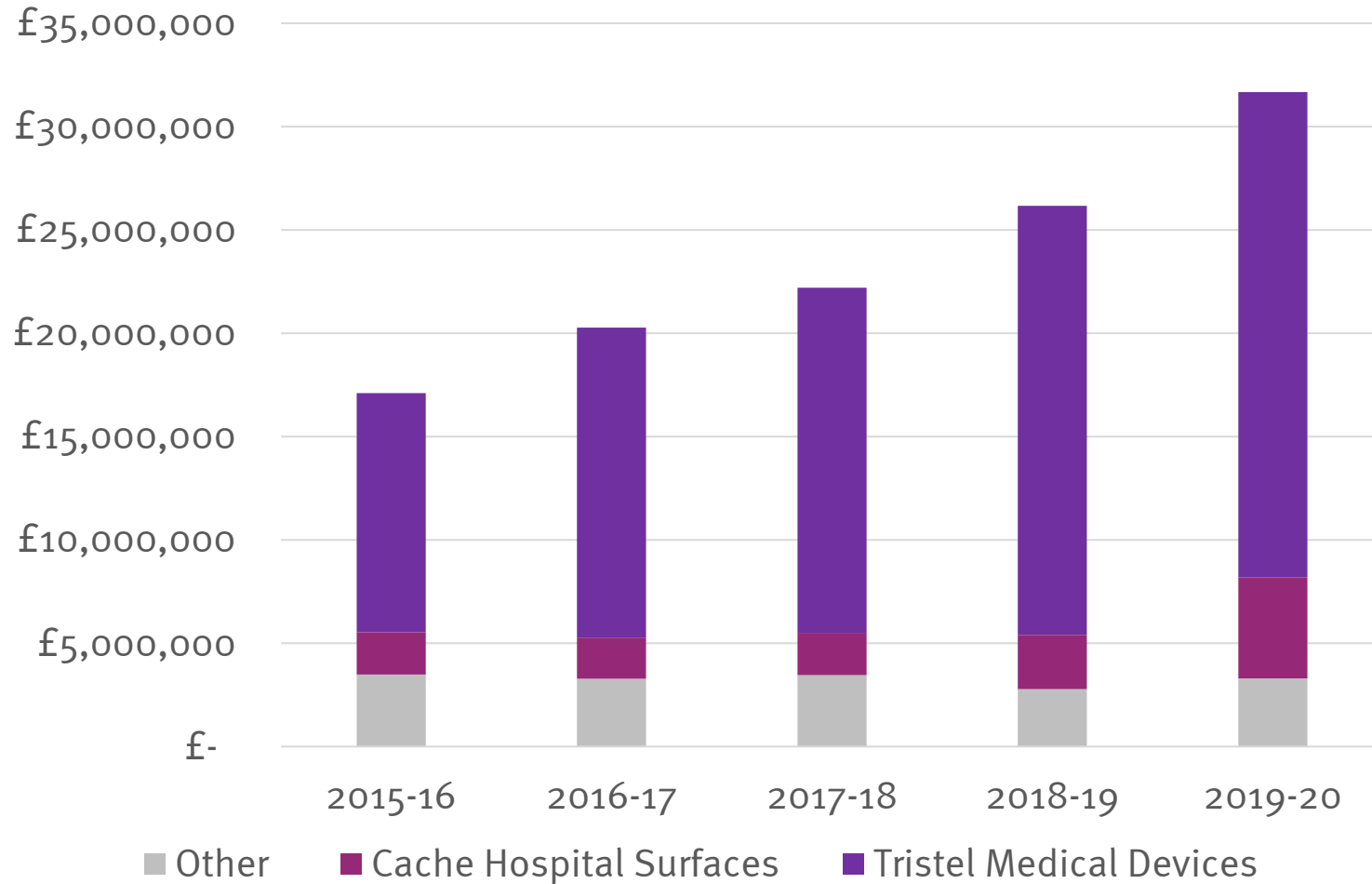

2019-20 in summary:

- Year on year £2.7m growth in Tristel medical device sales
- Year on year £2.3m growth in Cache surface sales

of which, we estimate, the COVID-19 impact was:

- £500k reduction in Tristel medical device sales
- £2m increase in Cache surface sales

SALES GROWTH BY CHANNEL

£,000	2018-19	2019-20	Year on year change	% change
Tristel Hospital Medical Device Decontamination				
UK & Europe direct	14,120	16,770	2,650	19%
APAC direct	4,140	4,610	470	11%
Distributors	2,510	2,120	(390)	-16%
	20,770	23,500	2,730	13%
Cache Hospital Surface Disinfection				
UK & Europe direct	2,280	3,890	1,610	71%
APAC direct	120	230	110	92%
Distributors	210	760	550	262%
	2,610	4,880	2,270	87%
Other (all geographies and channels)	2,790	3,300	510	18%
Total	26,170	31,680	5,510	21%

PANDEMIC IMPACT

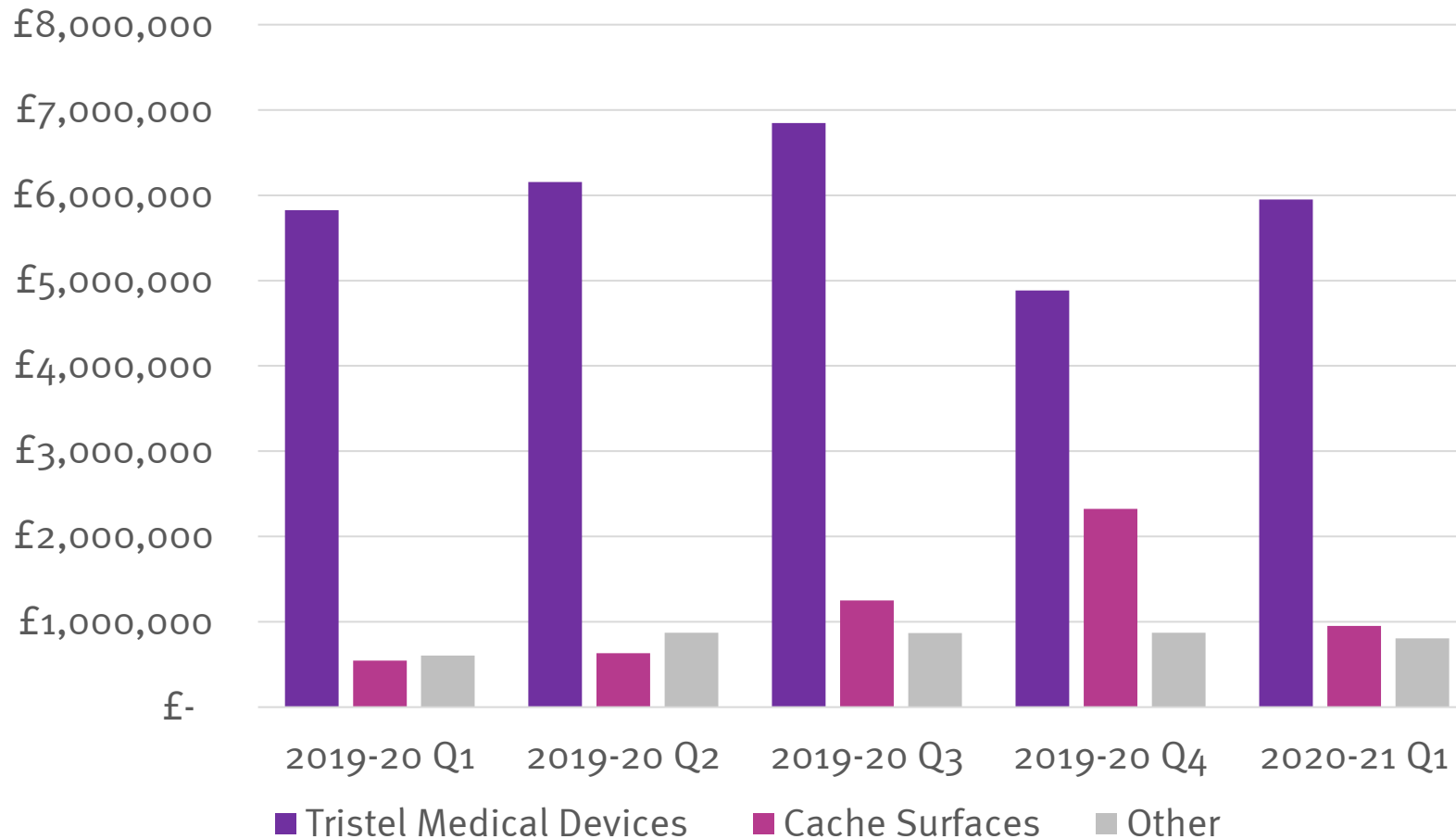

Quarter by quarter changes due to COVID-19:

- 2019-20 Q3: Hospitals build their stock of all infection prevention products
- 2019-20 Q4: Out-patient departments close to all but COVID patients. Reduced Tristel sales, but Cache sales hit an all time high
- 2020-21 Q1: Out-patient departments start to re-open, Cache sales remain at an enhanced level

FINANCIAL TARGETS

Key Performance Indicator	2018-19	2019-20	Target	Comment
Total revenue growth	18%	21%	10-15% per annum on average over three years	On target. The acquisitions of 2018 & 2019 contributed half of 2019-20 growth
EBITDA margin	27%	31%	No less than 25%	On target
APBT growth <small>(adjusted for share based payments)</small>	19%	27%	> 0%	On target

OPERATIONAL HIGHLIGHTS

- Successful integration of Tristel Italia srl, acquired for £0.6m in July 2019
- Additional 23,000 sq. ft. warehouse and office building fit out completed
- Regulatory approval received in India for Tristel Duo for Ultrasound
- Late stage negotiations with GE Healthcare India and Genworks Health to distribute Duo and other approved Tristel products throughout the country
- National distribution agreement signed with GE Healthcare Russia for ultrasound market
- North American market entry: continuing data generation for FDA submission, making a supplemental submission to the EPA to improve label claims for two products already approved, and first submission made to Canada Health

NORTH AMERICA

- EPA mycobacterial claim – data submitted. Response due February 2021
 - FDA usability study – scheduled in San Francisco for February 2021
 - FDA clinical evaluations – to be scheduled spring 2021

Ultrasound console:
EPA approved

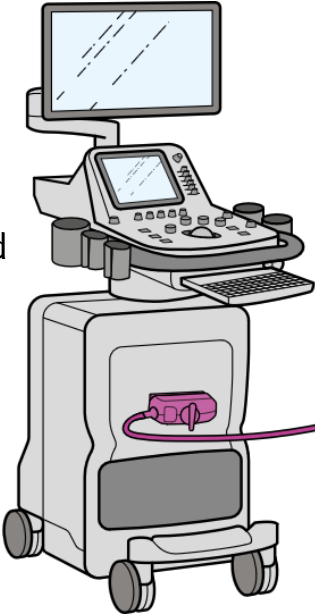

Ultrasound probe:
FDA seeking approval

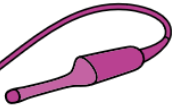

DUO Medical Device Disinfection

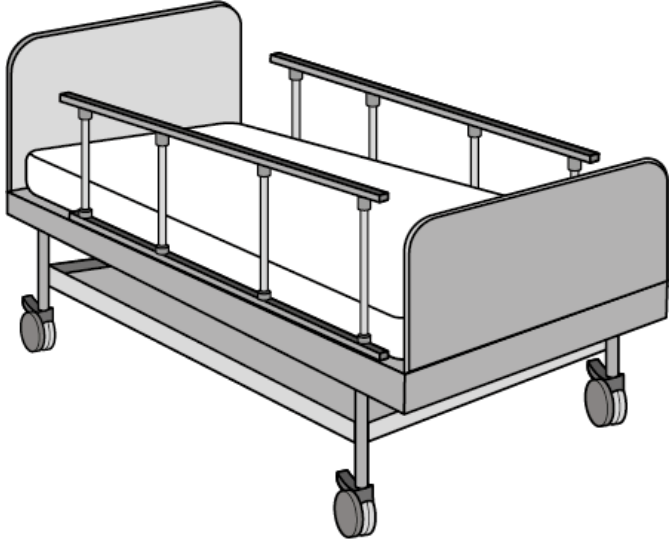

JET Hospital Surfaces Disinfection: EPA approved



NORTH AMERICA FY 2021 to FY 2023

Building the commitment to NA

- Allocate more internal resource to the UK based North America project team – Q2 FY 2021
- Recruit first North America based employee(s) – calendar 2021
- Appoint US NED, additional advisors and consultants – calendar 2021
- Budgeted investment FY 2021 £0.5m (2019-20 actual £80k)

Building the product portfolio in NA

- FDA: restart Duo ENT and OPH programmes
- FDA: new regulatory programmes for Stella + liquid ClO₂ for instrument soaking ›
manometry and urology
- EPA: new regulatory programmes for entire Cache Collection (Jet & Duo already approved)
- FDA / EPA: Rinse Assure rinse water management in endoscopy reprocessing
- Canada Health: Duo ULT & ENT, Stella and Cache collection
- Budgeted investment in new programmes FY 2021 £0.25m

SUMMARY

- Overseas expansion continues to drive growth
- Successful integration of acquisitions, targets met
- COVID-19 accelerates Cache and demonstrates business resilience
- Profitable, cash generative, debt-free
- No change to dividend policy
- New premises to support future growth
- Workforce in good shape

THANK YOU

APPENDIX – INCOME STATEMENT

	Year ended 30.06.20	Year ended 30.06.19
	£'000	£'000
Turnover	31,678	26,169
Cost of sales	(6,431)	(5,504)
Gross profit	25,247	20,665
Gross margin %	80%	79%
Administrative expenses	(15,419)	(13,579)
Net interest	(166)	4
Results from associate	-	45
Operating profit before amortisation & shared based payments	9,662	7,135
Amortisation & Depreciation	(2,588)	(1,537)
Share based payments	(435)	(852)
Pre-tax profit	6,639	4,746
Tax charge /(credit)	(1,621)	(715)
Profit after tax	5,018	4,031
Basic EPS – pence	11.38	9.14
Diluted EPS – pence	10.88	8.86

APPENDIX – BALANCE SHEET

	30.06.20	30.06.19
Non-current assets	£'000	£'000
Goodwill	5,626	5,150
Investments	807	872
Intangible assets	7,624	7,593
Property, plant and equipment	8,080	1,466
Deferred tax	1,544	709
	23,681	15,790
Current assets		
Inventories	4,619	2,957
Trade and other receivables	6,329	5,370
Cash and cash equivalents	6,212	4,170
	17,160	12,497
Total assets	40,841	28,287

Continued...

APPENDIX – BALANCE SHEET ...Continued

	30.06.20	30.06.19
	£'000	£'000
Capital and reserves		
Share capital	453	446
Share premium account	12,634	11,427
Merger reserve	2,205	2,205
Foreign exchange reserve	397	83
Retained earnings	12,767	9,191
Non-controlling interests	7	7
Total equity	28,463	23,359
Current liabilities		
Trade and other payables	4,579	3,539
Current tax	1,182	839
Other current liabilities	817	-
Total current liabilities	6,578	4,378
Deferred tax	615	550
Other non-current liabilities	5,117	-
Total liabilities	12,378	4,928
Total equity and liabilities	40,841	28,287

APPENDIX – CASH FLOW RECONCILIATION

	Year ended 30.06.20	Year ended 30.06.19
	£'000	£'000
Profit before tax	6,639	4,746
Add back non-cash items	3,108	2,391
Working capital movements	(1,617)	(775)
Purchase of tangible fixed assets	(1,770)	(678)
Purchase of intangible assets	(610)	(669)
Purchase of investments	(595)	(4,826)
Payment of lease liabilities (IFRS16)	(614)	-
Dividends paid	(2,621)	(2,210)
Shares issued	1,214	383
Corporation tax paid	(1,140)	(871)
Increase/(Decrease) in cash	1,994	(2,509)